

C42 Ceiling PoE Line

Ceiling bt PoE Switches

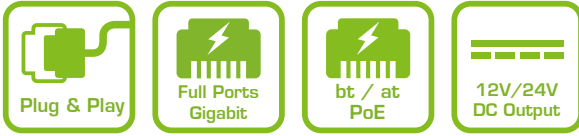

AETEK's unmanaged C42-050-030 Ceiling PoE Switch line with one PoE PD input port, five PoE PSE output ports, and visible LED indicator benefits from low-cost installation quick diagnostic, and low-voltage safety DC power deployment. C42-050-30-B unparalleled daisy-chain PoE feature extends long range PoE up to 300m over cat 5e/cat 6 cable without extra AC/DC power adapter in ceiling. Furthermore C42-050-30-B provides DC 12V & DC 24V output for non-IP DC device.

Features

- No costly electrical installation required
- Eliminating conventional electrical supply reducing the fire event in the ceiling
- No need to switch off the power anywhere when PoE or non-PoE device is expanded or changed in ceiling
- Supports 10/100/1000Mbps data rates
- Support Auto-MDI/MDIX
- IEEE 802.3az Energy Efficient Ethernet standard for green power

Applications

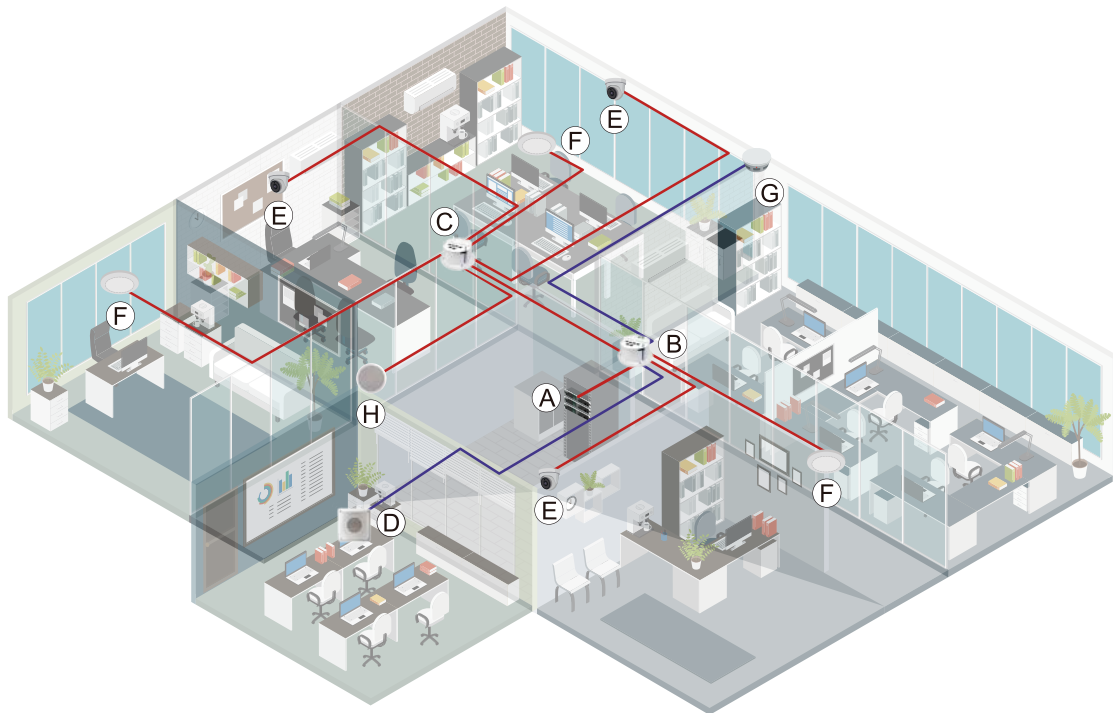

PoE (Data + Power) — DC Power

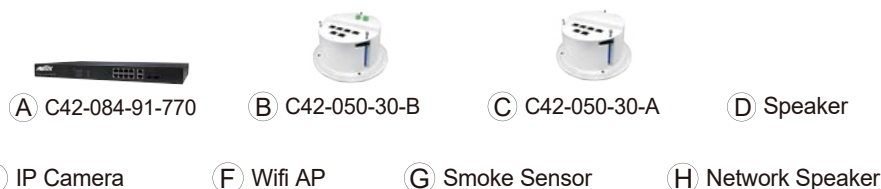

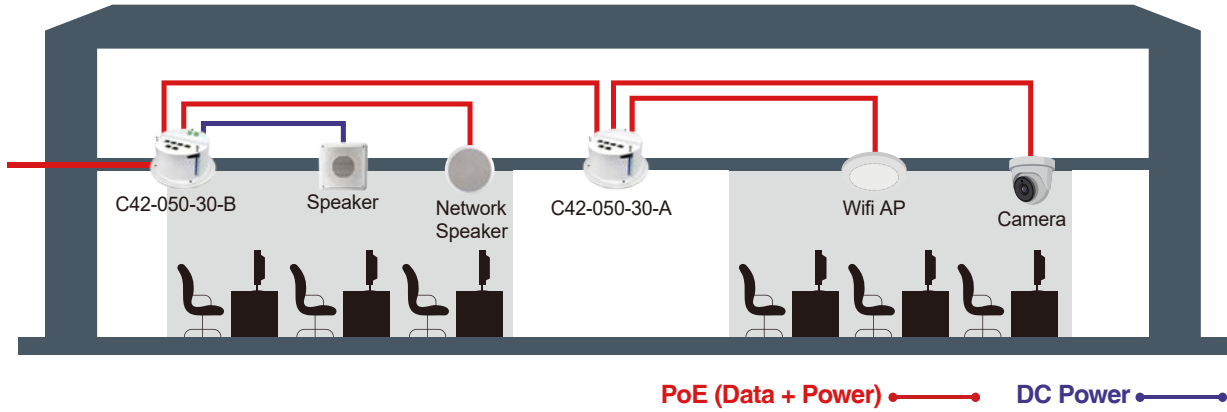





Technical Specifications-Hardware

	C42-050-30-A	C42-050-30-B
Network Specifications		
GbE PoE PSE Ports	1 x bt PoE Output 4 x at PoE Output	1 x bt PoE Output 4 x at PoE Output
GbE PoE PD Port	1 x bt PD Input	1 x bt PD Input
Power Input	Class 8 bt PoE	Class 8 bt PoE
Daisy-Chain	-	Support
Reset Button	Support	Support
Power Output	-	12VDC/2.5A x 1, 2Pin Terminal Block 24VDC/1.25A x 1, 2Pin Terminal Block
Forwarding Capacity	8.928Mpps	8.928Mpps
Mac Table	8 K	8 K
Jumbo Frames	9,216 Bytes	9,216 Bytes
Switching Capacity	12 Gbps	12 Gbps
LED Indicator	PWR, LAN, PoE	PWR, LAN, PoE, 12VDC, 24VDC
Mechanical Specifications		
Dimensions	H90×φ185.16 mm	H90×φ185.16 mm
Recommended ceiling opening	φ150 mm	φ150 mm
Recommended ceiling thickness	5 to 45 mm	5 to 45 mm
Case material	PC	PC
Weight	0.8KG	1KG
Environmental Specifications		
Operating Temperature	0°C ~ 50°C (32°F ~ 122°F)	0°C ~ 50°C (32°F ~ 122°F)
Storage Temperature	-20°C ~ 70°C (-4°F ~ 158°F)	-20°C ~ 70°C (-4°F ~ 158°F)
Operating Humidity	10% to 90% non-condensing	10% to 90% non-condensing
Certifications		
EMC	CE, FCC, VCCI, C-Tick	CE, FCC, VCCI, C-Tick

Ordering Information

Ceiling PoE Switch Line			
	C42-050-30-A <ul style="list-style-type: none"> 1xGbE bt PD PoE Input 1xGbE bt PoE + 4xGbE at PoE PSE Output 		C42-050-30-B <ul style="list-style-type: none"> 1xGbE bt PD PoE Input 1xGbE bt PoE + 4xGbE at PoE PSE Output 12V/24VDC Output Support Daisy-Chain

Related Product

bt PoE Switch Line			
	C42-042-91-380 <ul style="list-style-type: none"> 4xGbE bt PoE + 2xGbE Switch 380W Power Budget 		C42-084-91-770 <ul style="list-style-type: none"> 8xGbE bt PoE + 2xGbE RJ45 + 2xGbE SFP Switch 770W Power Budget